

PawHut

IN230900315V01_GL

D51-150V01

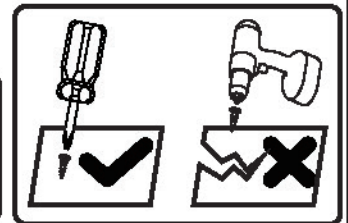
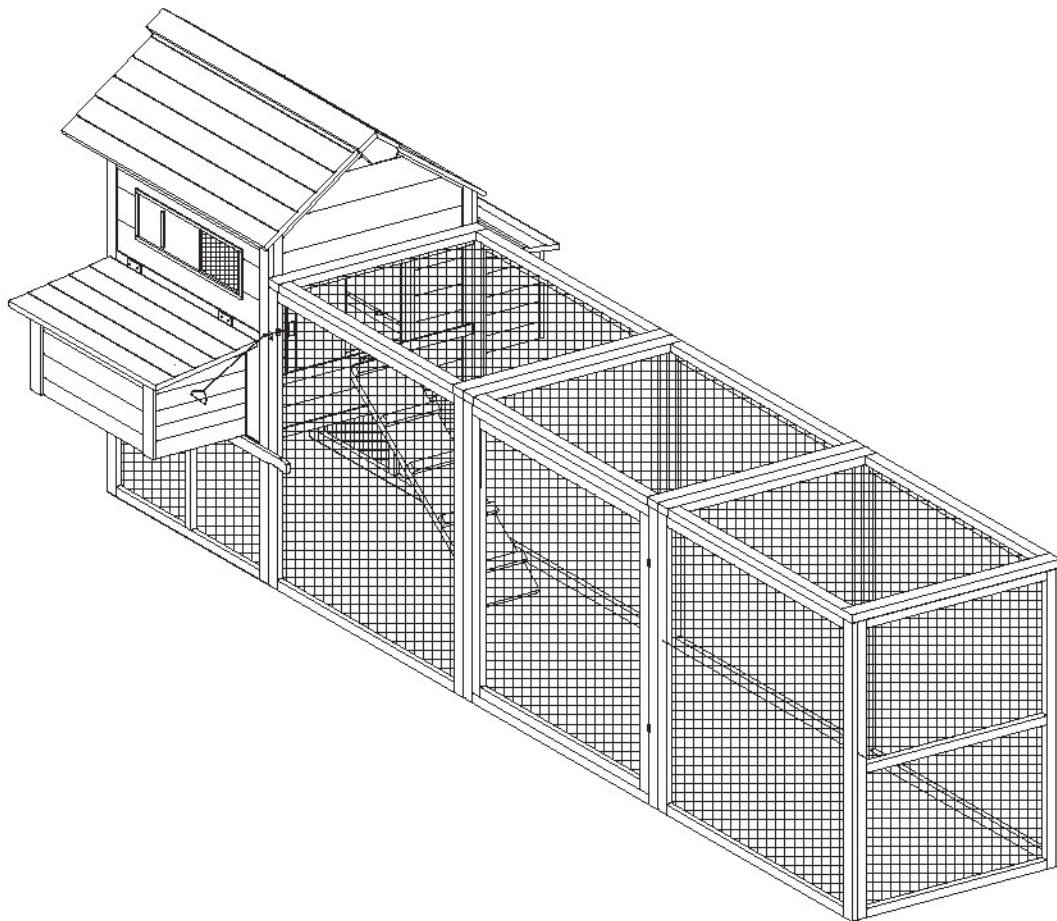

Tools Recommended

EN_IMPORTANT, RETAIN FOR FUTURE REFERENCE: READ CAREFULLY.

FR_IMPORTANT: A LIRE ATTENTIVEMENT ET À CONSERVER POUR CONSULTATION ULTÉRIEURE.

ES_IMPORTANTE, LEA Y GUARDE PARA FUTURAS REFERENCIAS.

PT_IMPORTANTE, RETER PARA REFERÊNCIA FUTURA: LEIA ATENTAMENTE.

DE_WICHTIG! SORGFÄLTIG LESEN UND FÜR SPÄTER NACHSCHLAGEN AUFBEWAHREN.

IT_IMPORTANTE! CONSERVARE IL PRESENTE MANUALE PER FUTURO RIFERIMENTO E LEGGERLO ATTENTAMENTE.

**BOX
1-2**

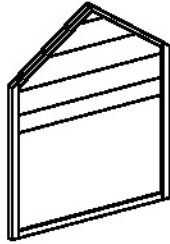

② 1pc

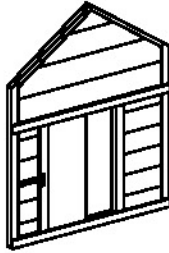

③ 1pc



④ 2pcs

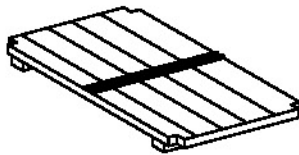

⑦ 2pcs

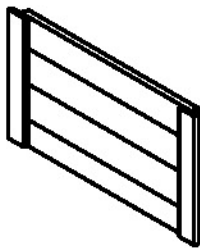

⑧ 2pcs



⑩ 2pcs

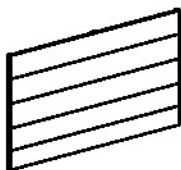

⑭ 1pc

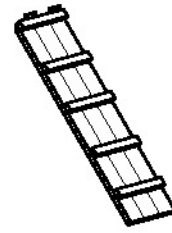

⑮ 1pc

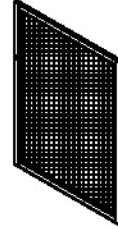

⑯ 1pc

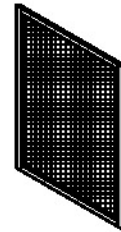

⑰ 2pcs

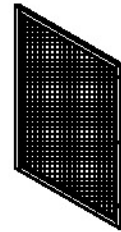

⑱ 2pcs

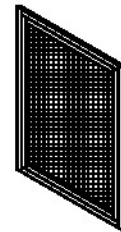

⑲ 1pc

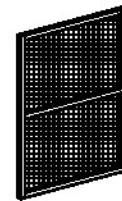

⑳ 1pc

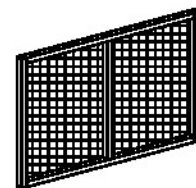

㉓ 1pc

**BOX
1-2**

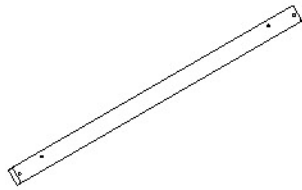

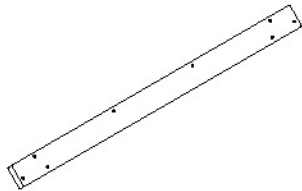

24 1pc



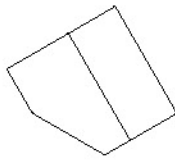









25 1pc

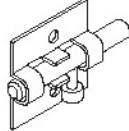

26 2pcs

A	 3.5*50	22pcs +2
B	 3.5*35	40pcs +2

C	 3.5*30	20pcs +1
D	 3*25	4pcs
E	 3*16	48pcs +2
F	 $\phi 6 * 45$	8pcs +1
G		1pc
H		3pcs
I		1pc
J		2pcs
K		3pcs
L		1pc

**BOX
2-2**

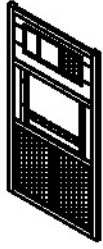

① 2pcs

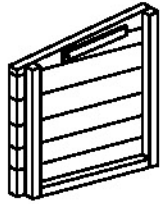

⑤ 2pcs

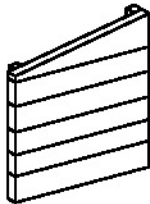

⑥ 2pcs

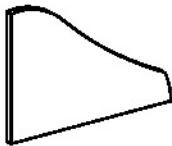

⑨ 2pcs

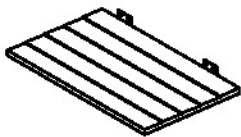

⑪ 2pcs



⑫ 1pc

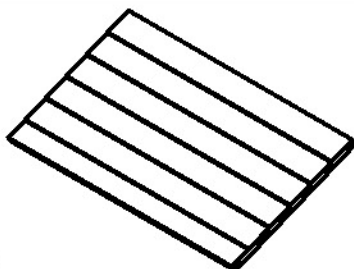

⑬ 2pcs

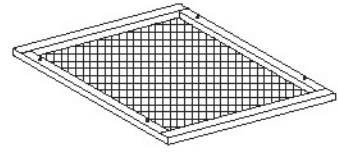

⑳ 2pcs

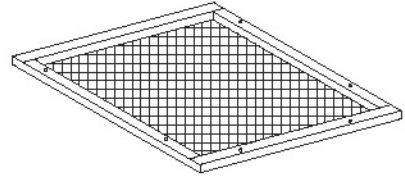

㉒ 1pc

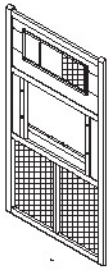

①x02

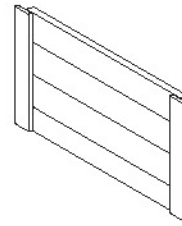

⑧x02

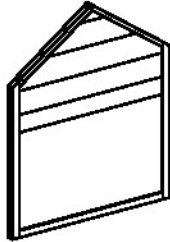

②x01

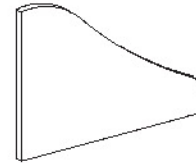

⑨x02

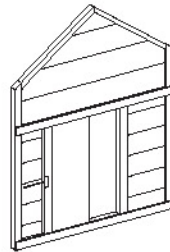

③x01

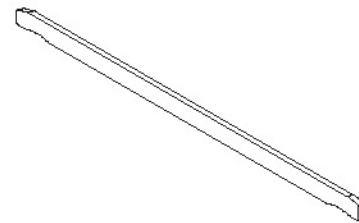

⑩x02



④x02

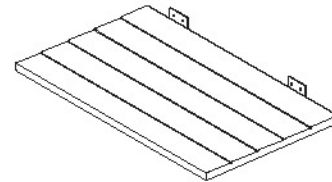

⑪x02

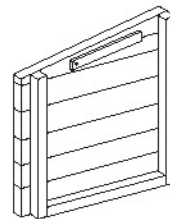

⑤x02

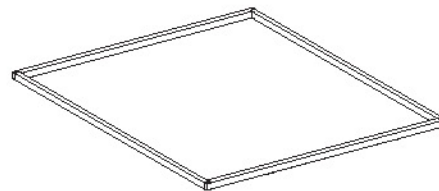

⑫x01

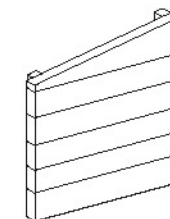

⑥x02

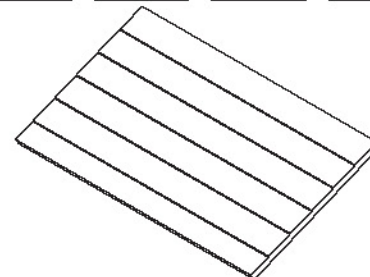

⑬x02

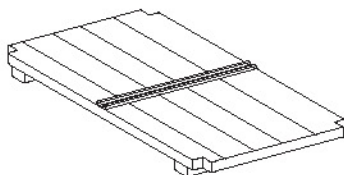

⑦x02



⑭x01



15 x01

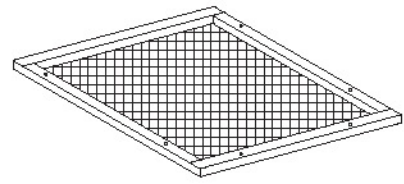

22 x01

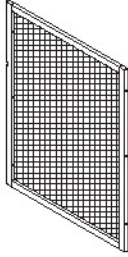

16 x01

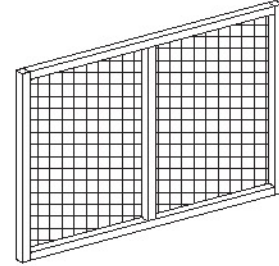

23 x01

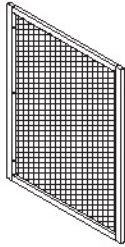

17 x02

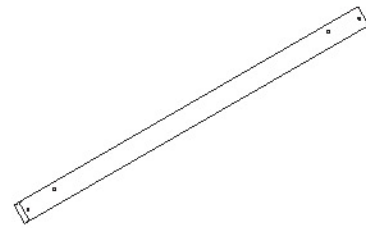

24 x01

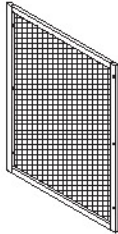

18 x02

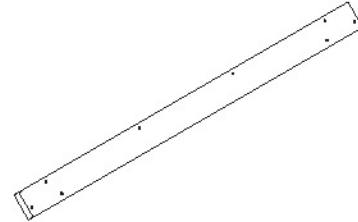

25 x01

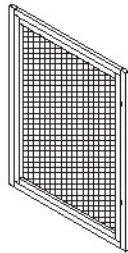

19 x01

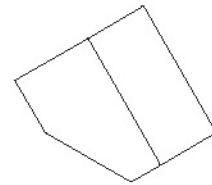

26 x02

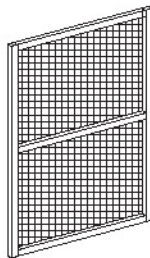



20 x01

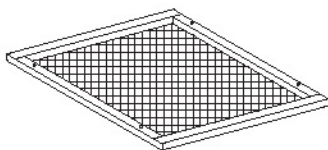
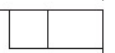

21 x02

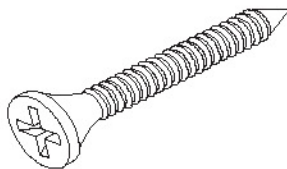
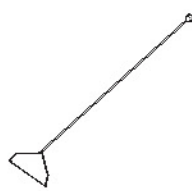
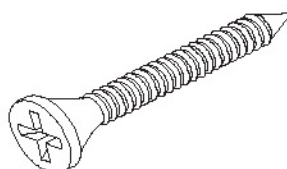

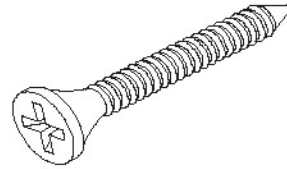
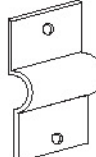
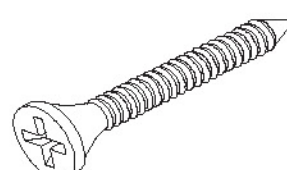
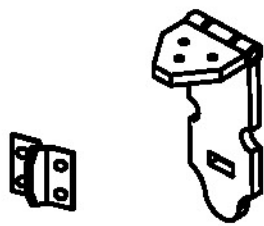
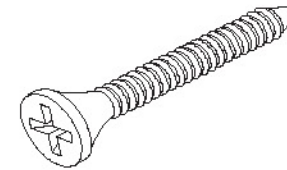
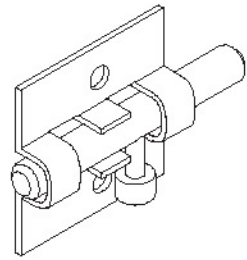
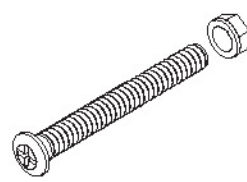
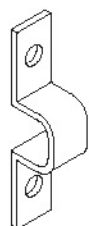
<p>A x22+2(spare)</p>  <p>M3.5*50</p>	<p>G x01</p> 
<p>B x40+2(spare)</p>  <p>M3.5*35</p>	<p>H x03</p> 
<p>C x20+1(spare)</p>  <p>M3.5*30</p>	<p>I x01</p> 
<p>D x04</p>  <p>M3*25</p>	<p>J x02</p> 
<p>E x48+2(spare)</p>  <p>M3*16</p>	<p>K x03</p> 
<p>F x08+1(spare)</p>  <p>M6*45</p>	<p>L x01</p> 

EN Do not confuse similar screws.
FR Ne pas confondre des vis similaires.
ES No confunda tornillos similares.
PT Não confundir parafusos semelhantes.
DE Verwechseln Sie ähnliche Schrauben nicht.
IT Non confondere le viti simili.

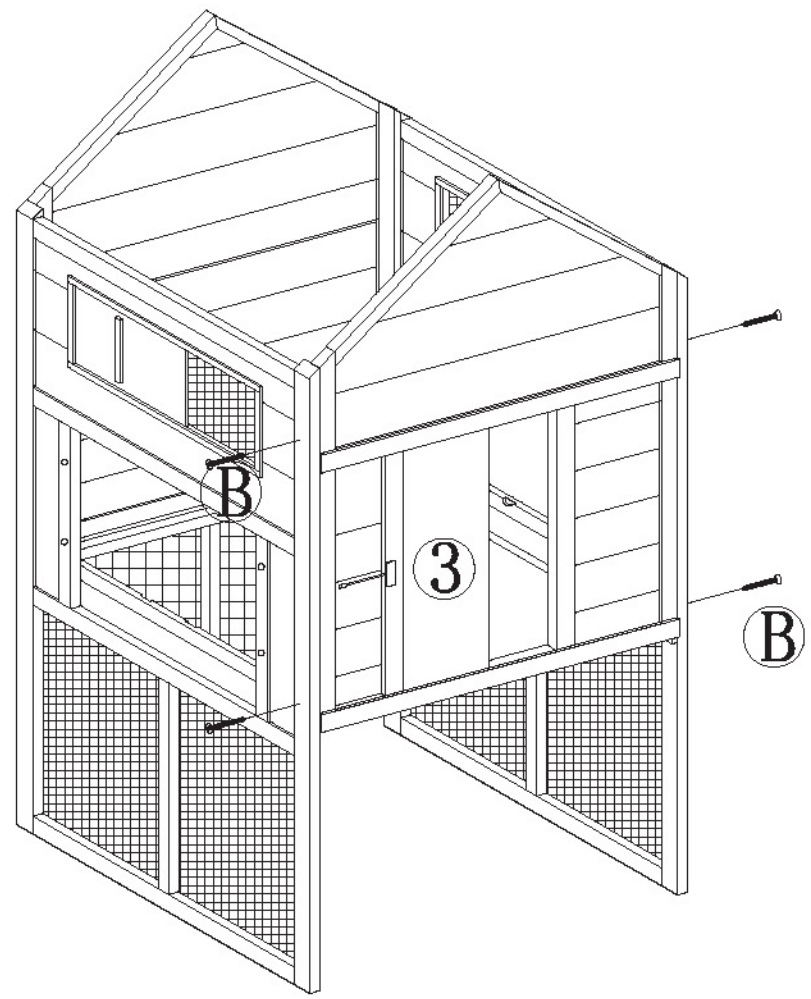
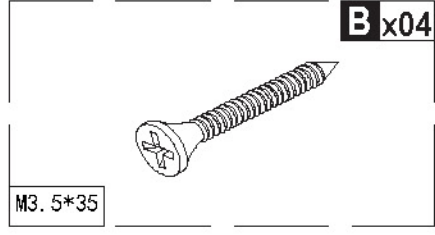
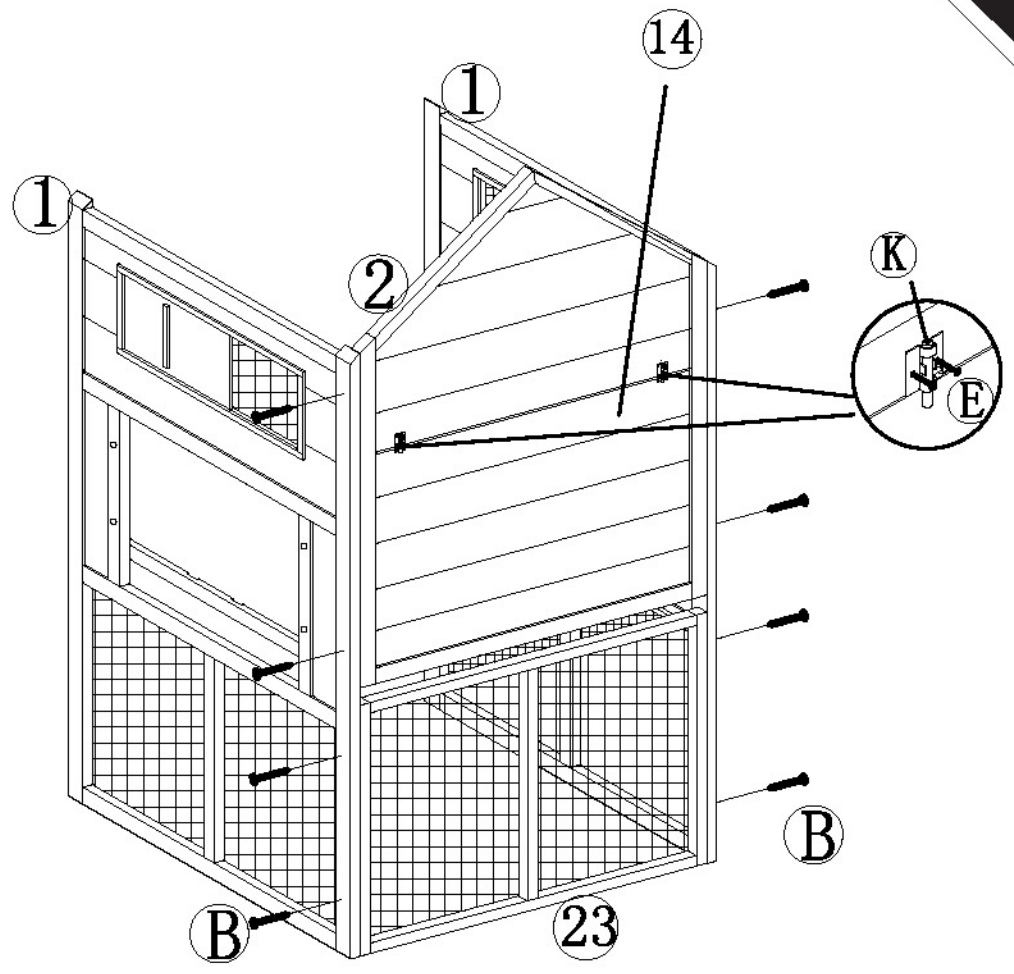
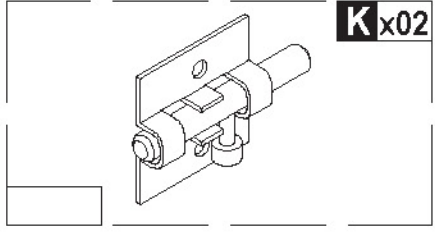
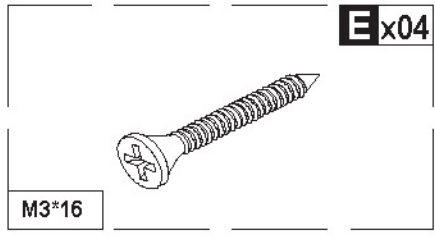
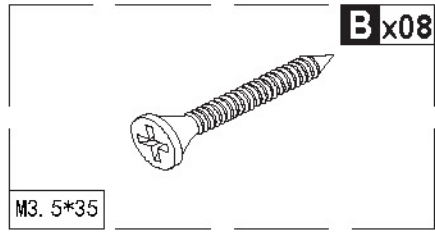

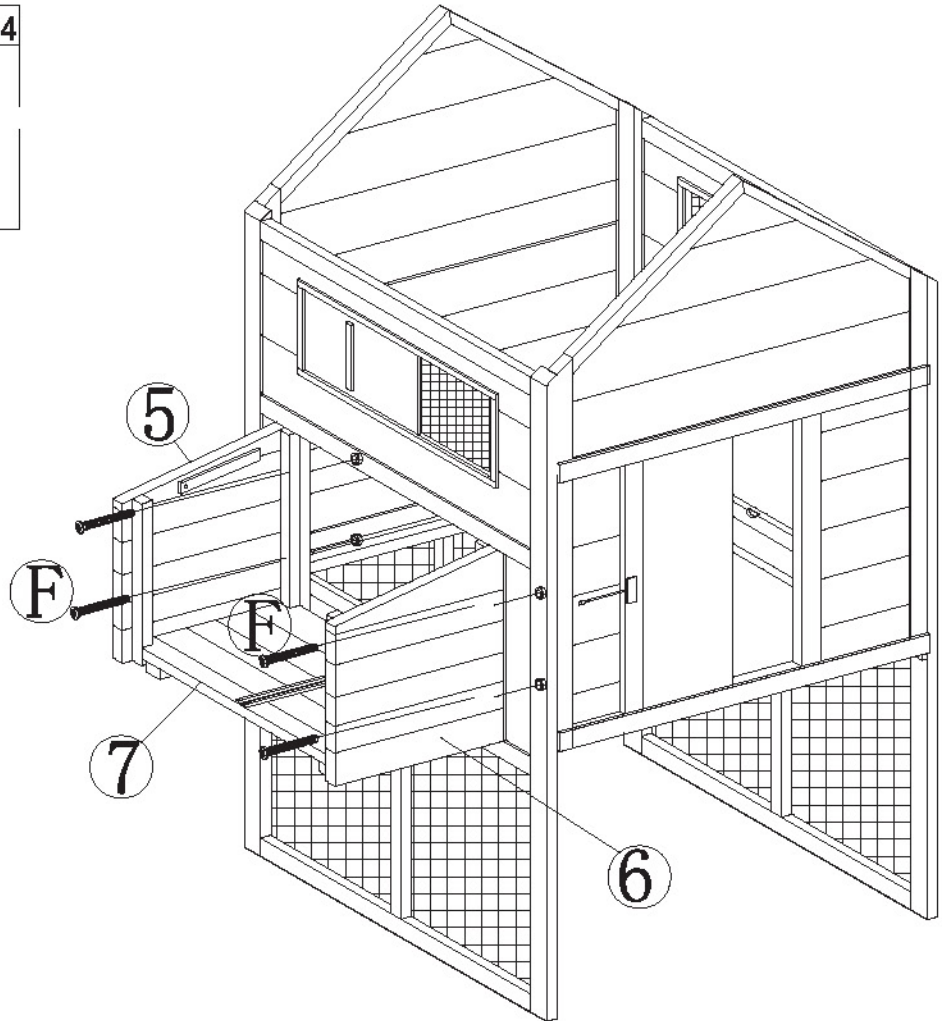
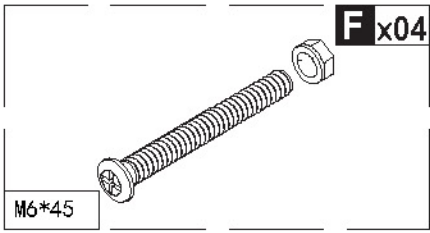
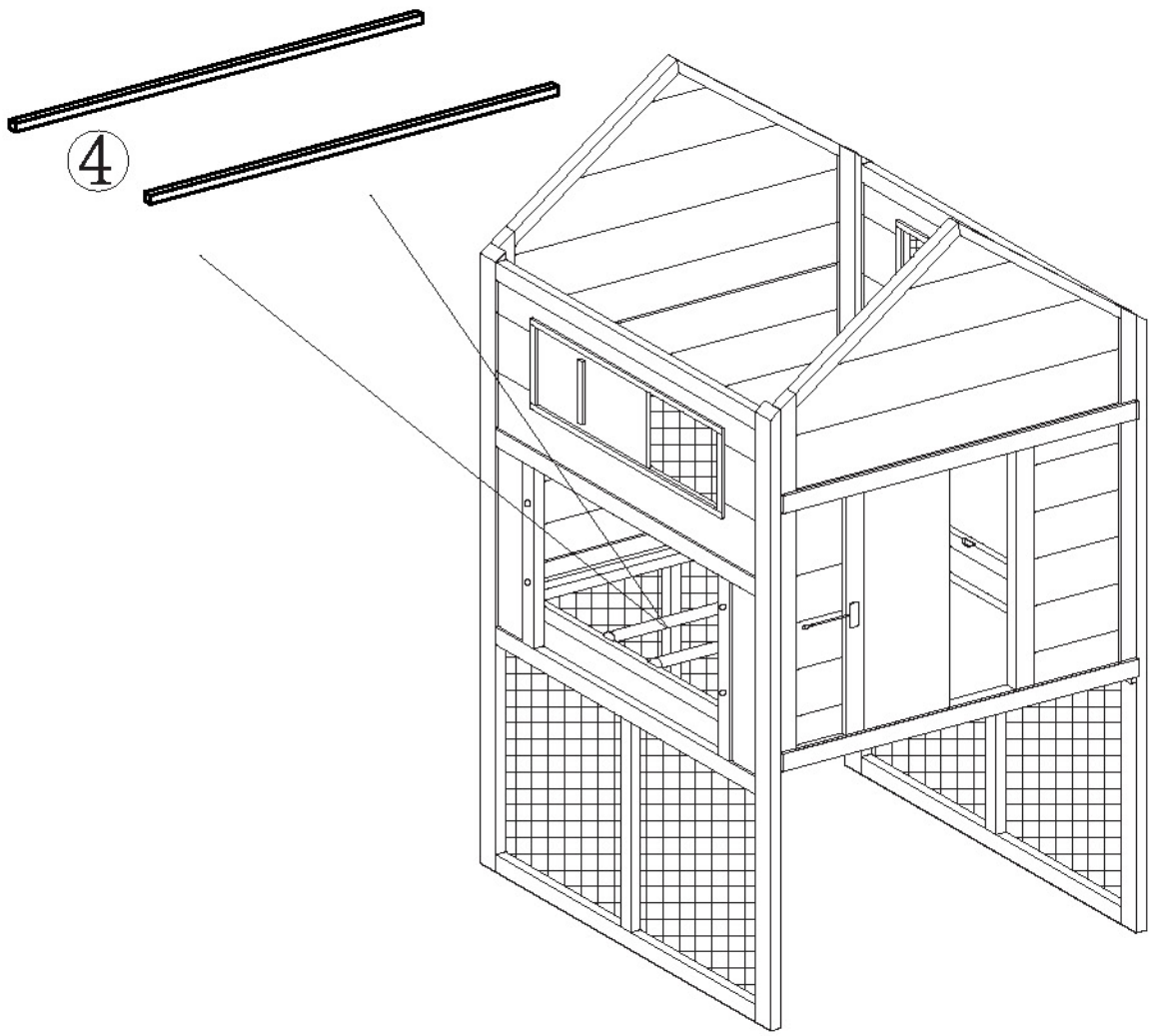

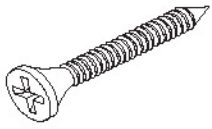

Bx04

M3. 5*35

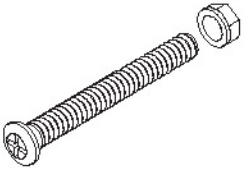
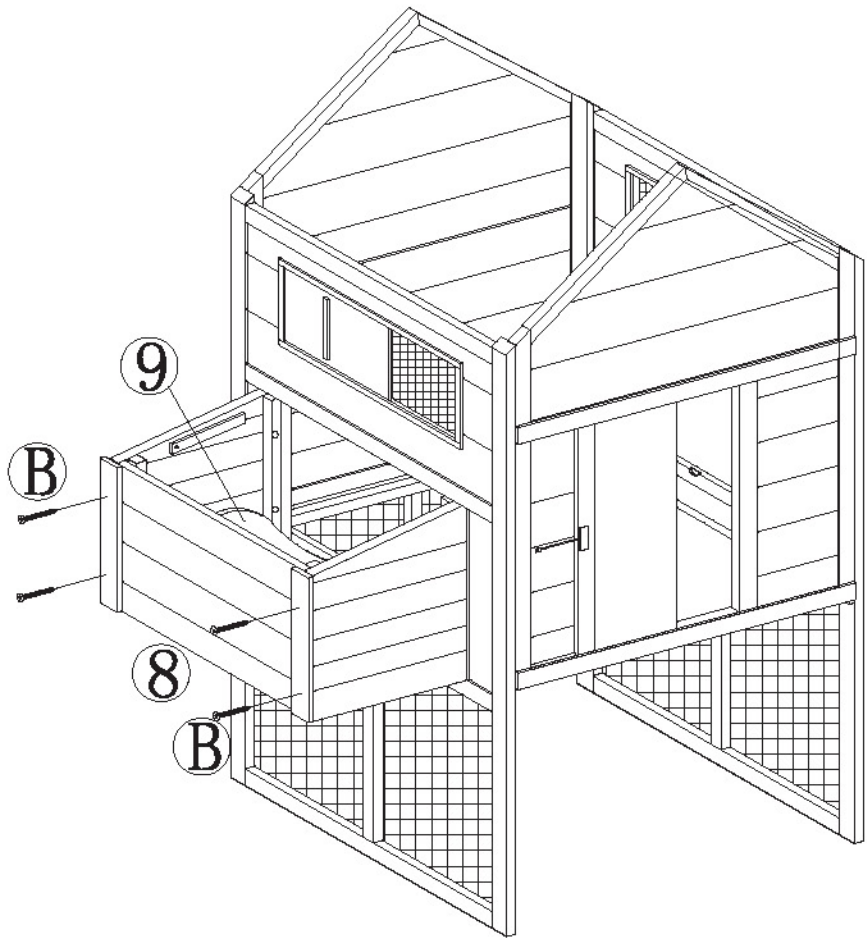

Fx04

Ø6*45

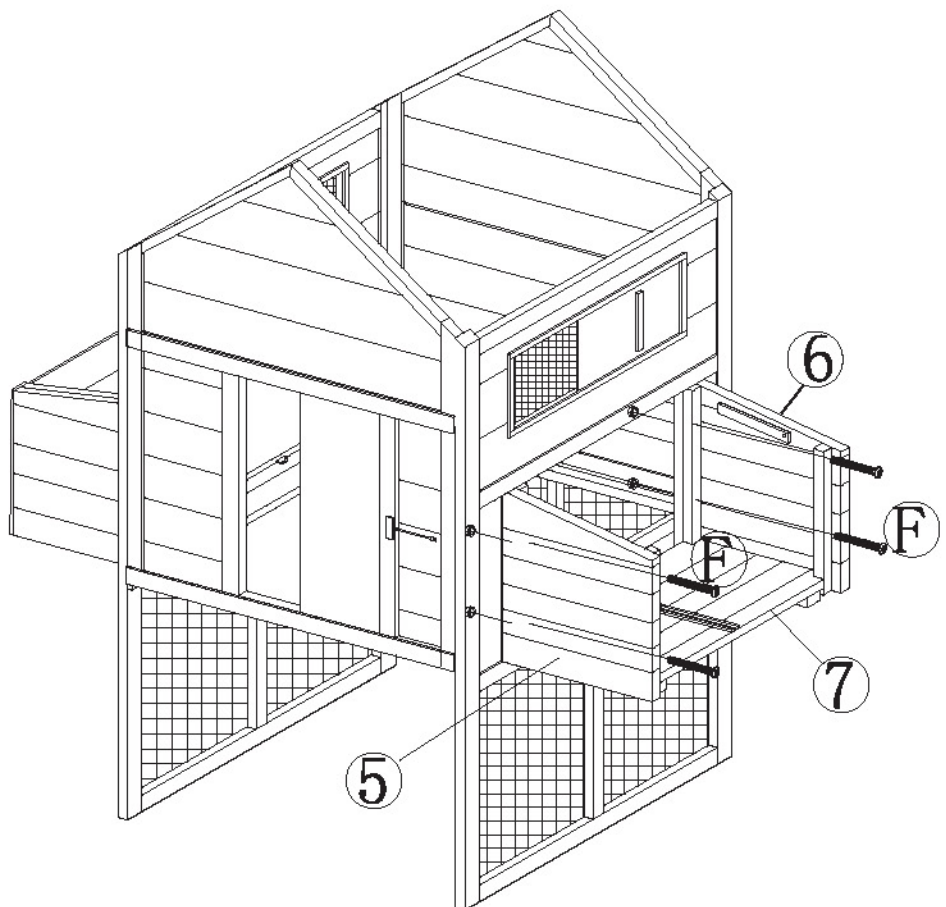

Bx04

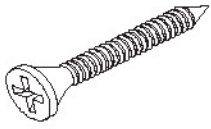

M3. 5*35

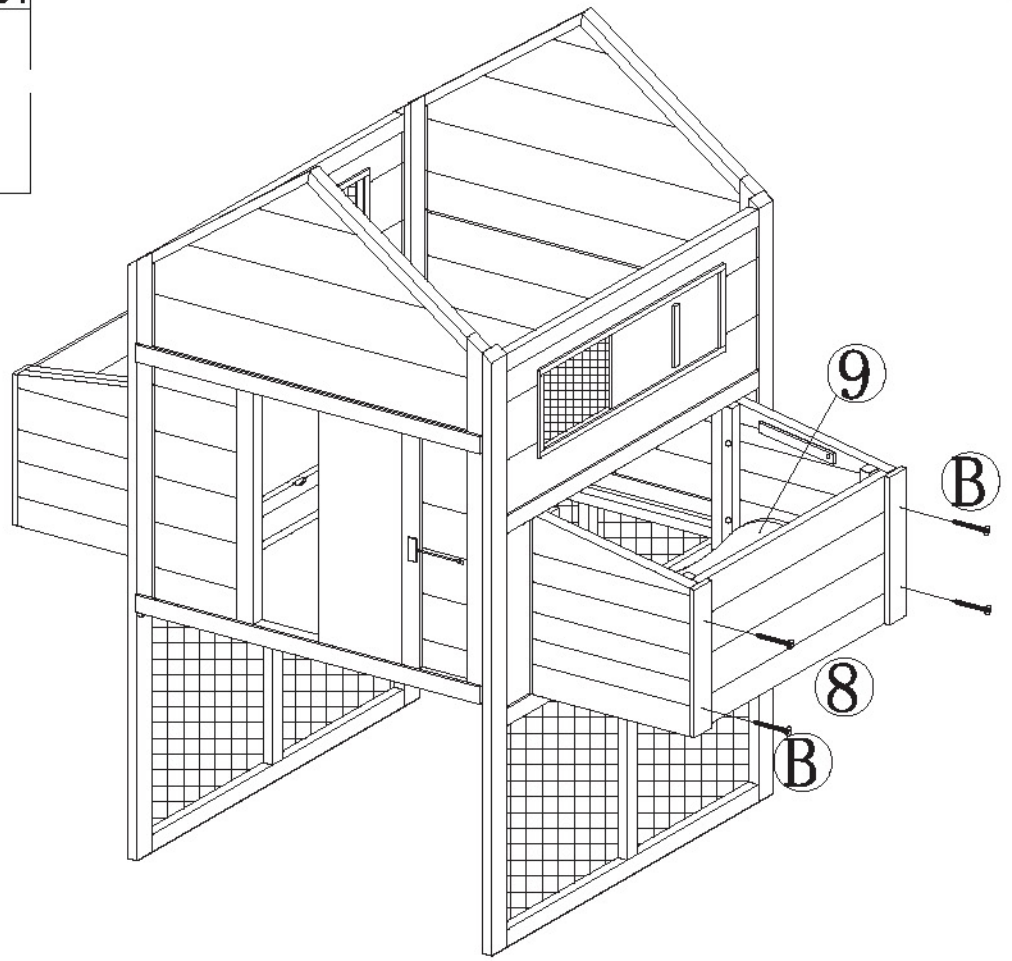

Cx02

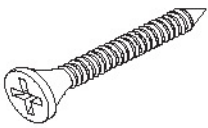

M3. 5*30

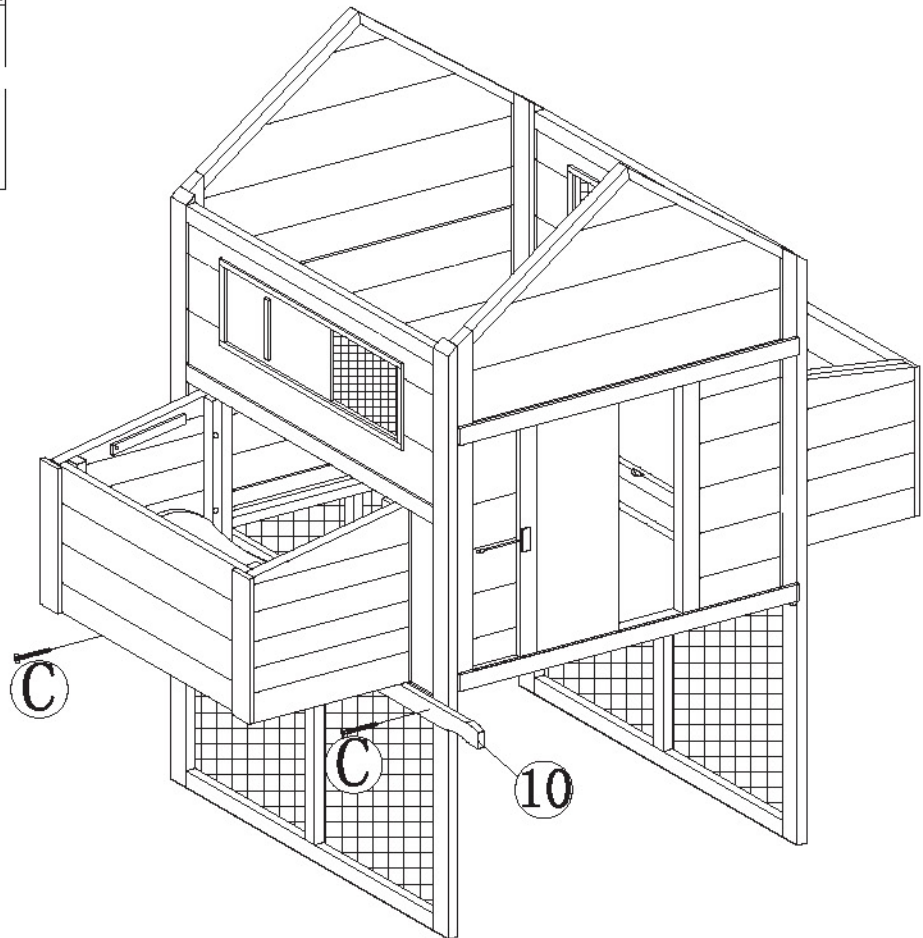

Cx02

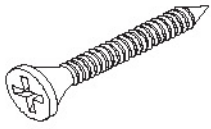

M3. 5*30

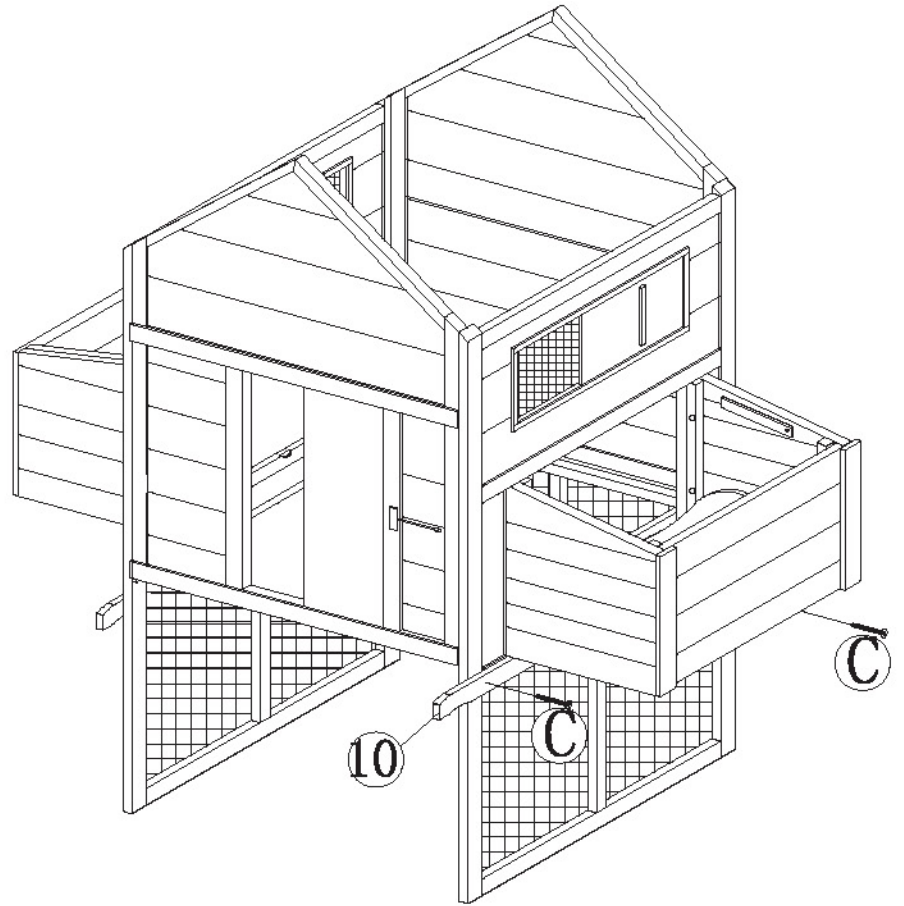

Ex11

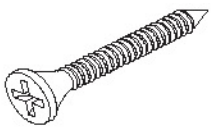

M3*16

Jx01

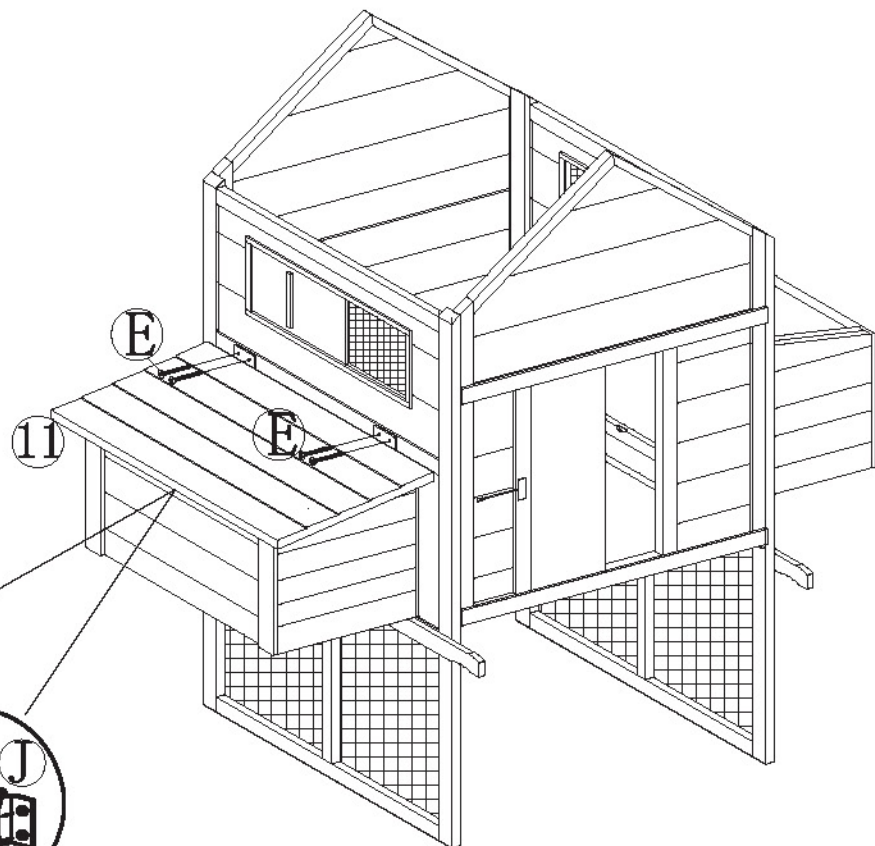
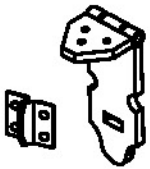

Ex11

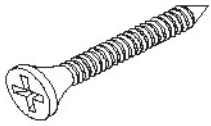

M3*16

Jx01

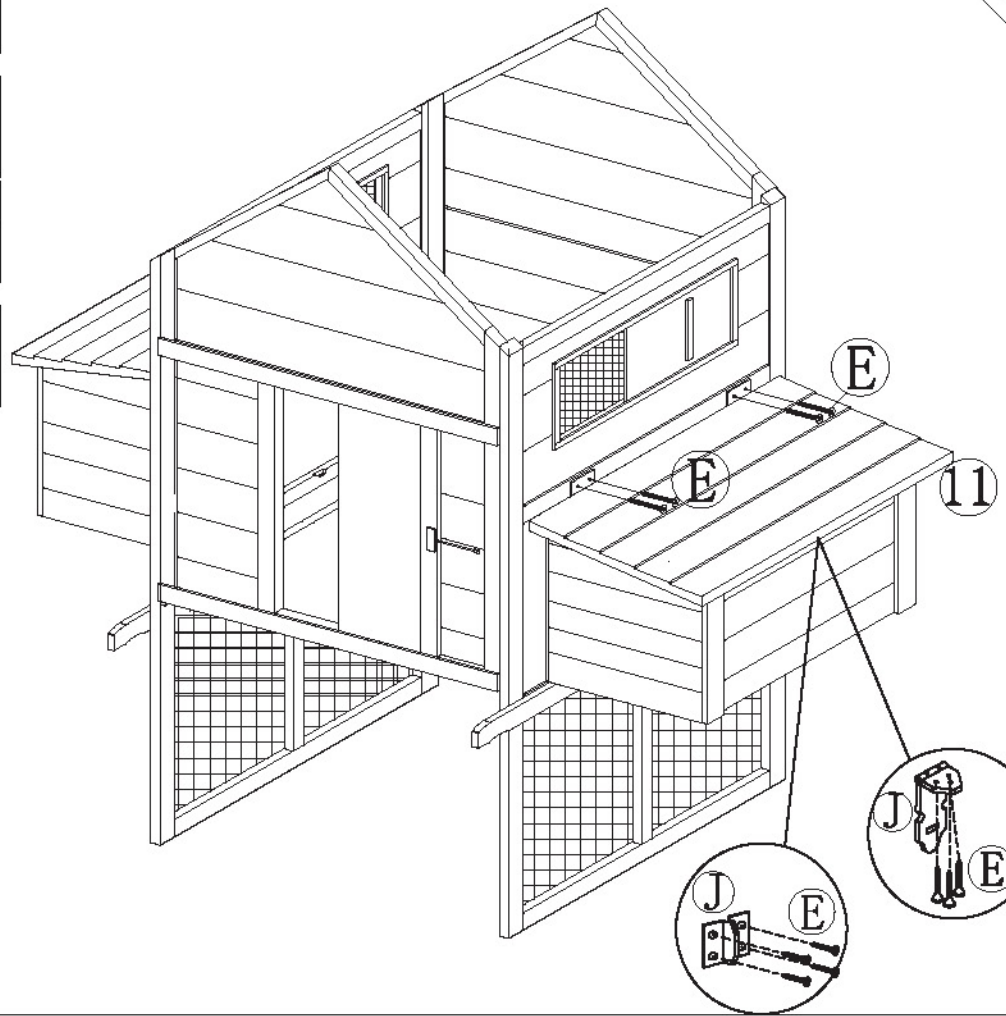
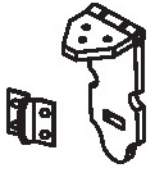

Ex12

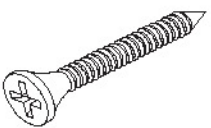

M3*16

Hx03

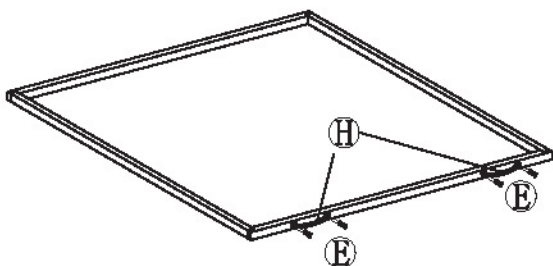
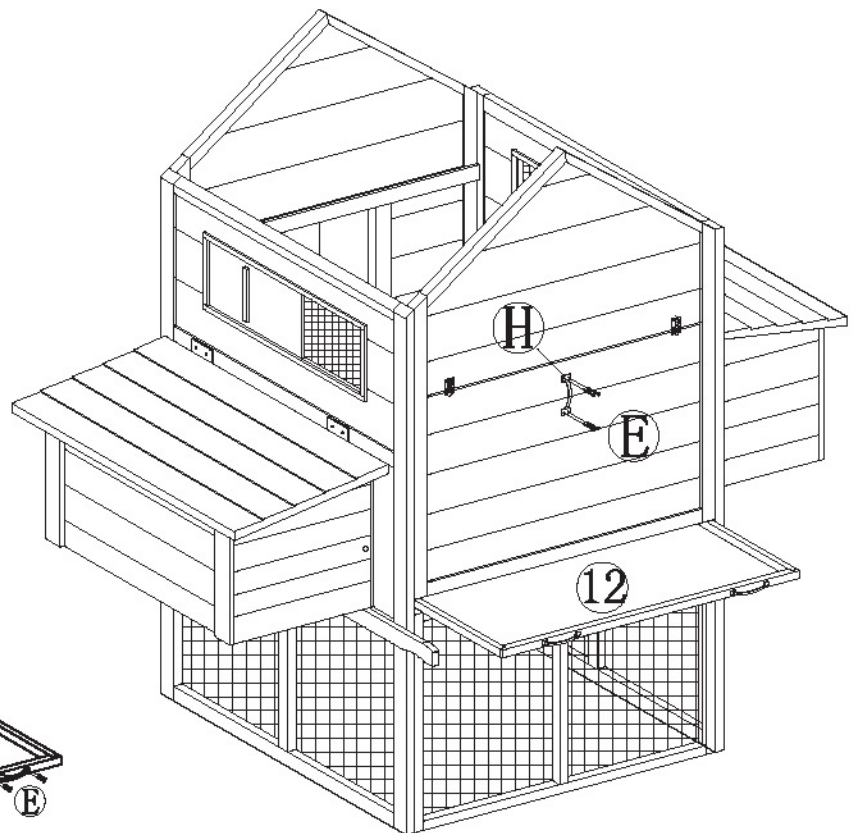

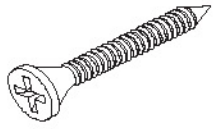

Cx08

M3. 5*30

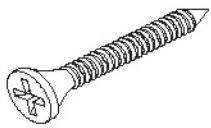
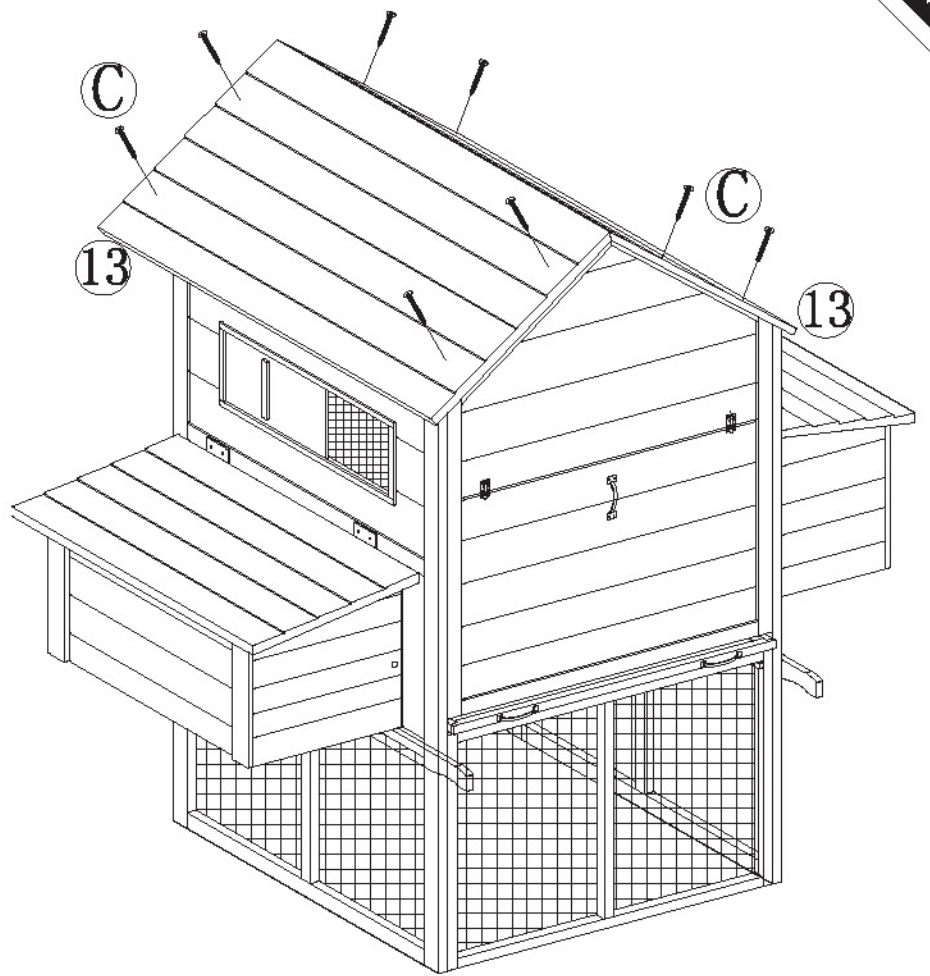

Cx08

M3. 5*30

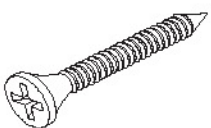

Dx04

M3*25

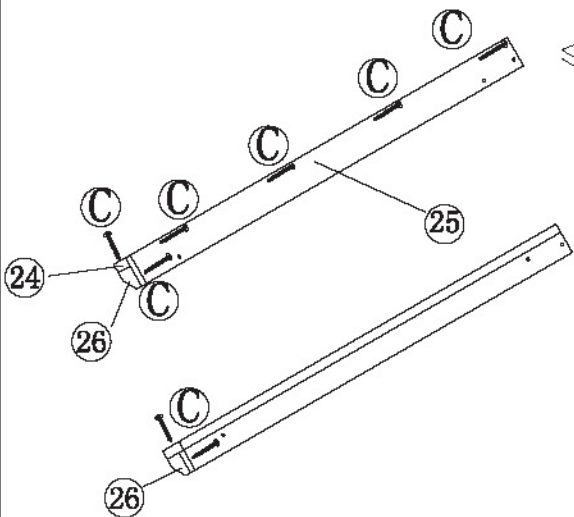
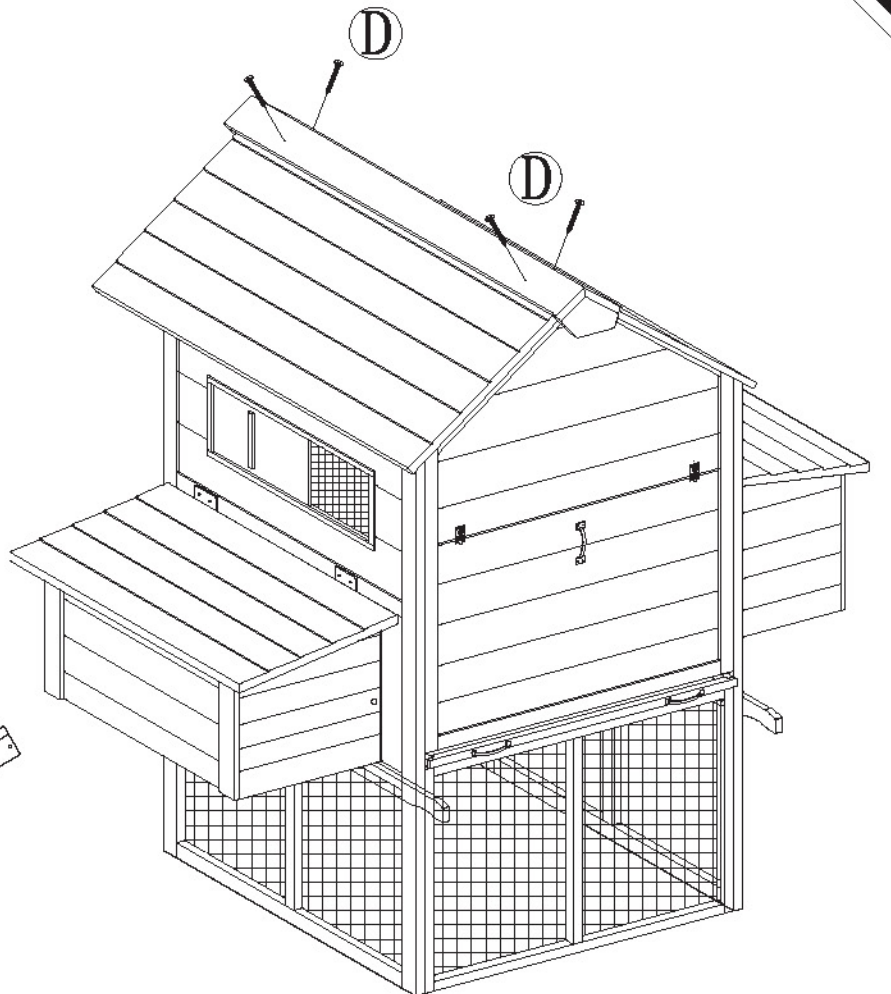

Ex06

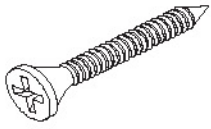

M3*16

Gx01

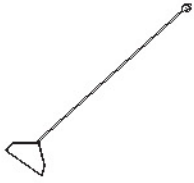

Ix01

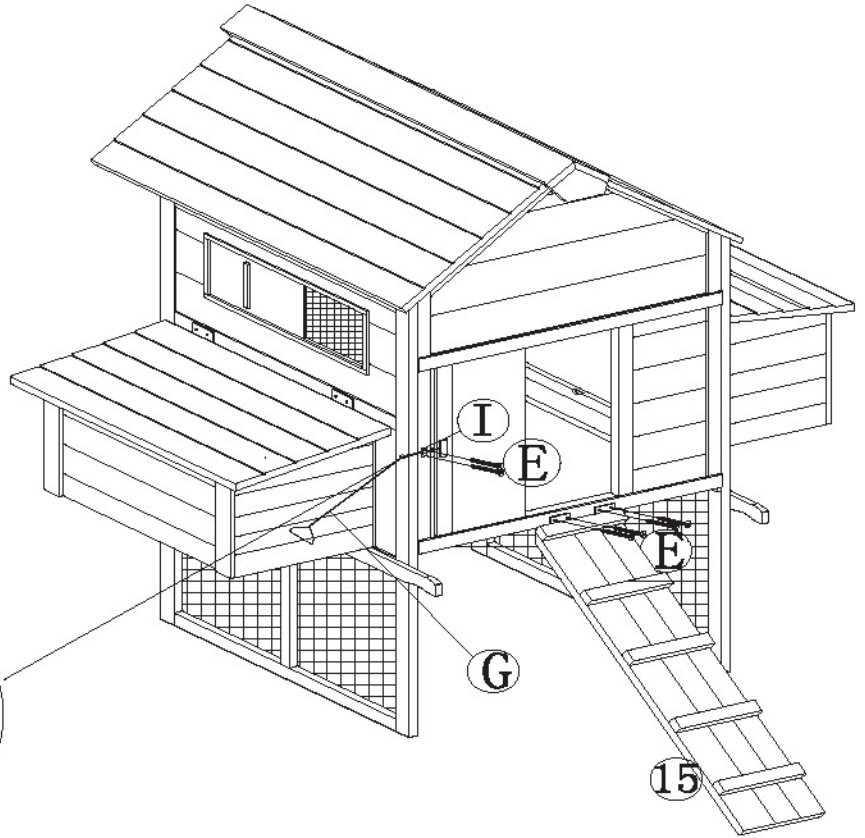
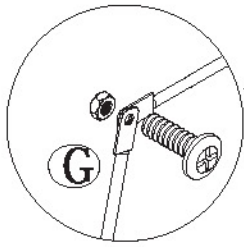
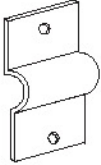

Ax06

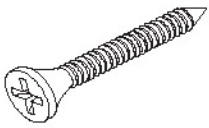

M3.5*50

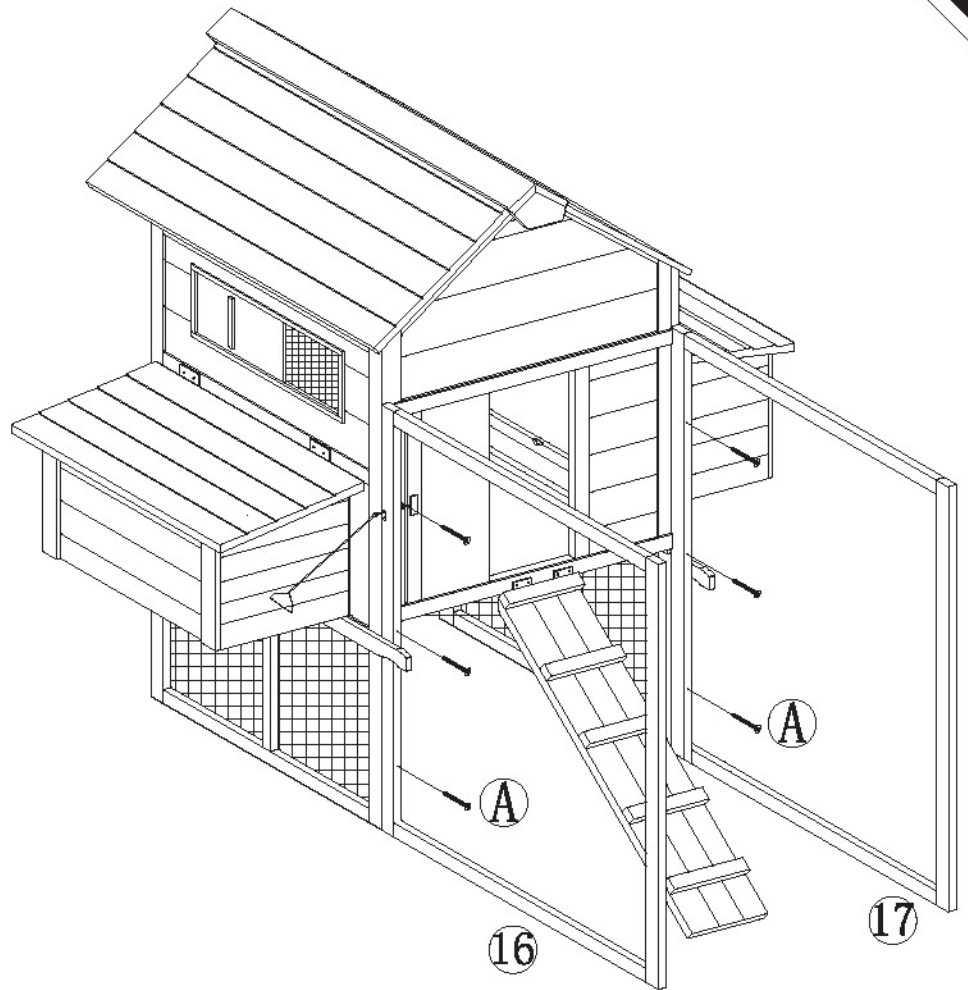

Ax06

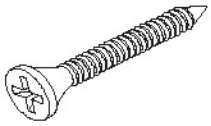

M3. 5*50

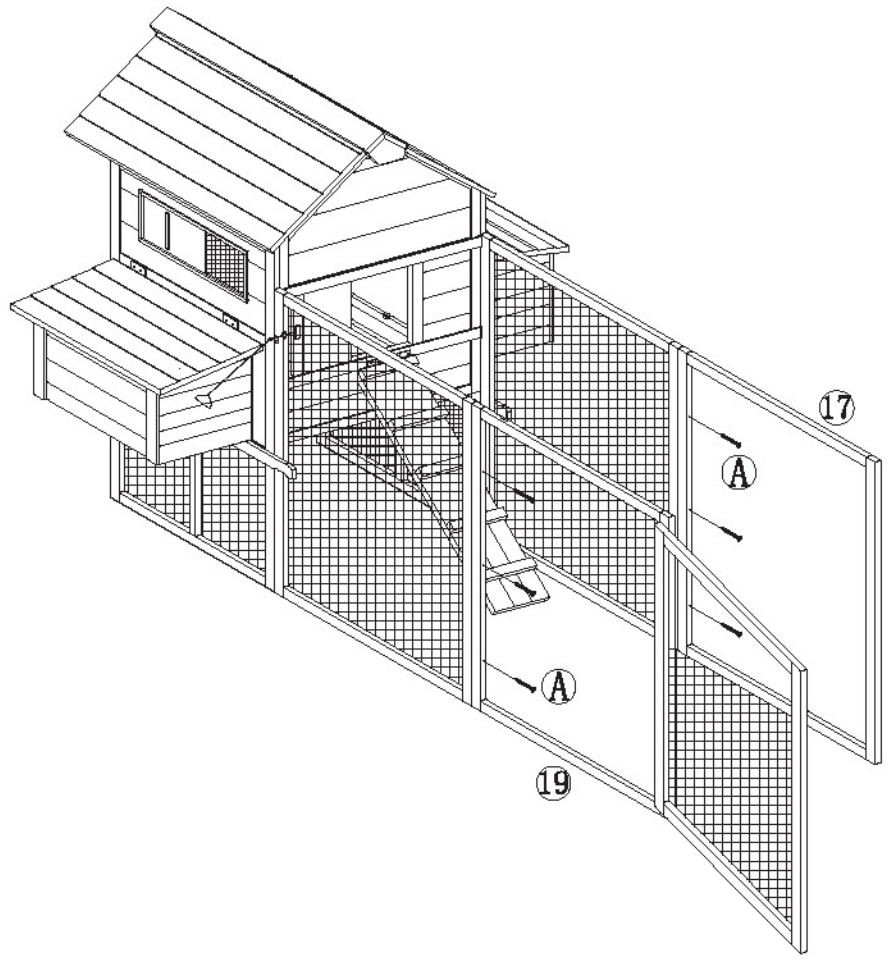

Ax06

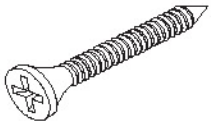

M3. 5*50

Ex04

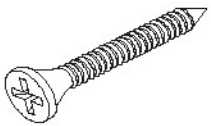

M3*16

Kx01

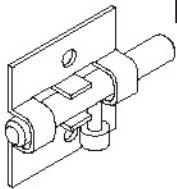

Lx01

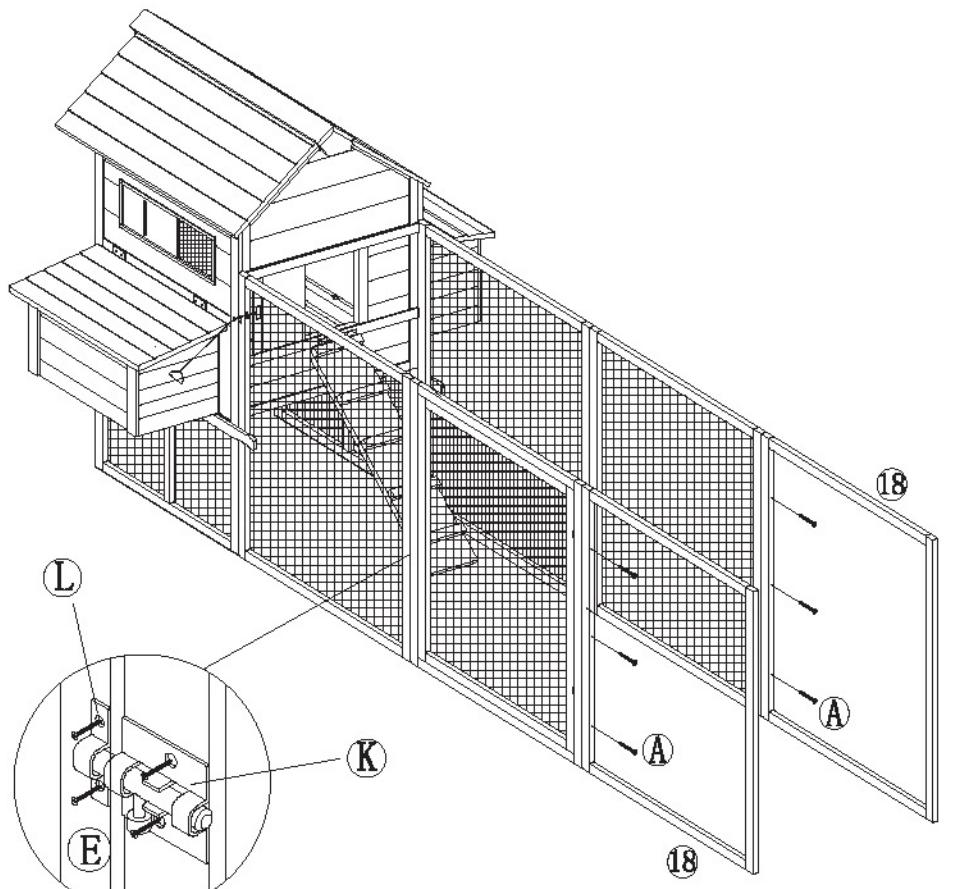
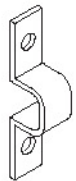

Ax04

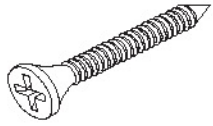

M3.5*50

Bx06

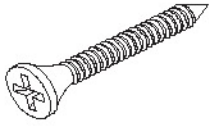

M3.5*35

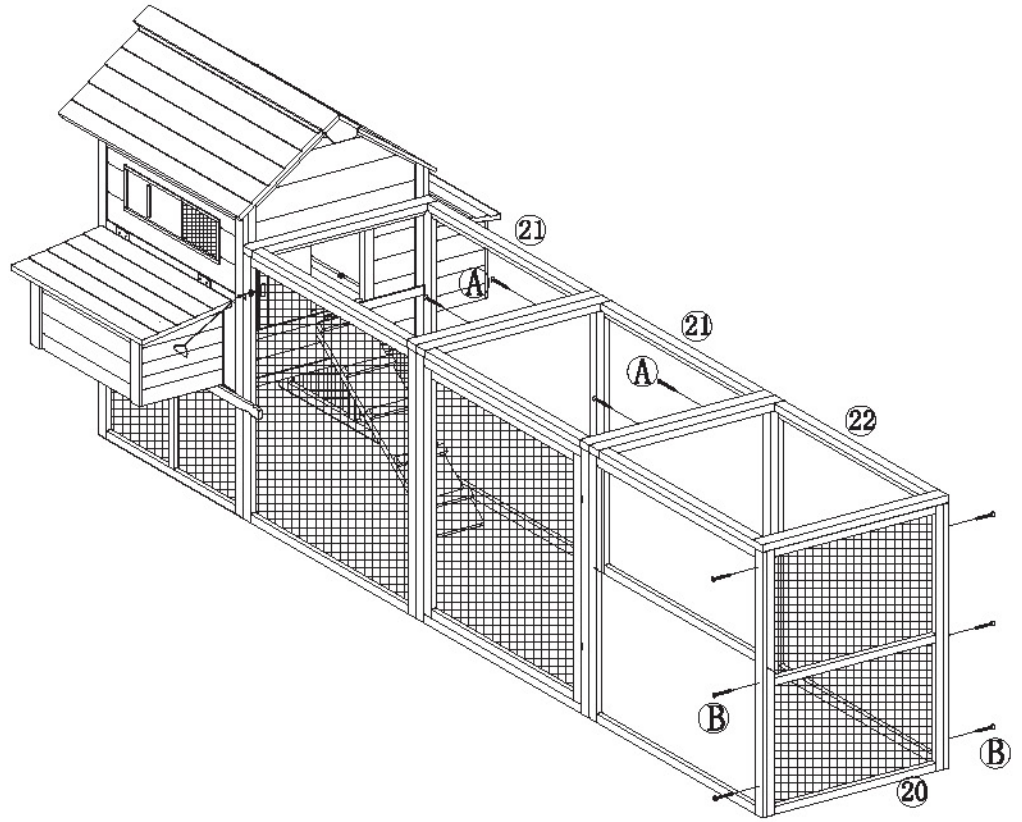

Bx14

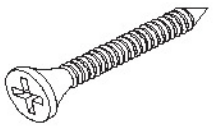

M3.5*35

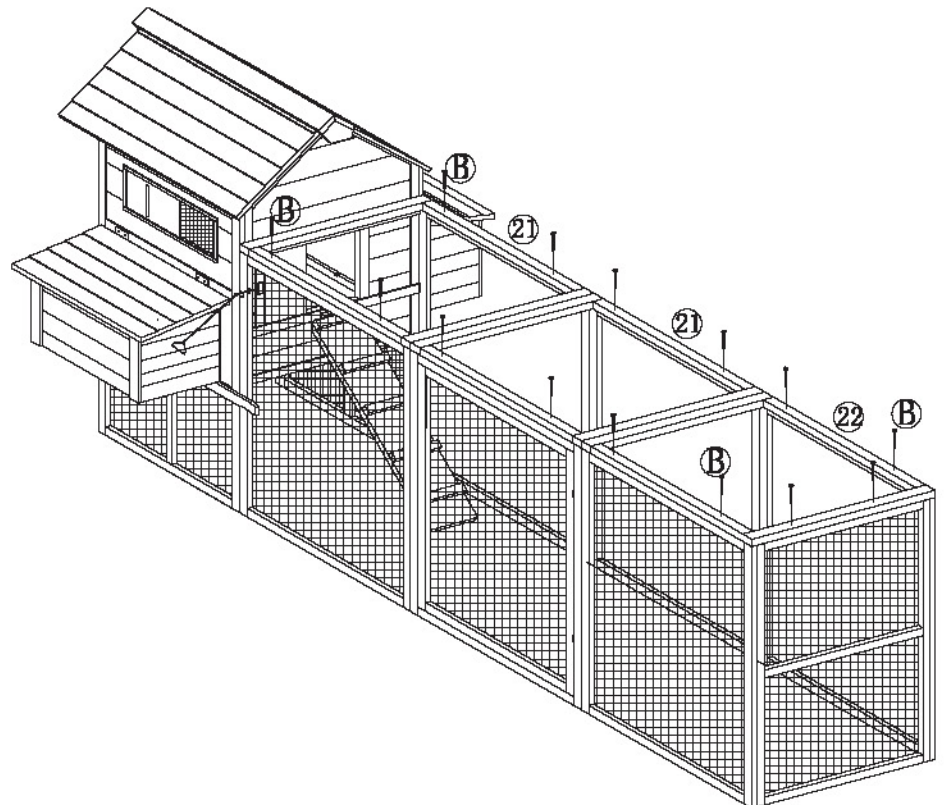

US

If you have any questions, please contact our customer care center.

Our contact details are below:

 001-877-644-9366

 customerservice@aosom.com

Imported by Aosom LLC
27150 SW Kinsman Rd Wilsonville, OR 97070 USA
MADE IN CHINA

CA

If you have any questions, please contact our customer care center.

Our contact details are below:

Si vous avez la moindre question, veuillez contacter notre centre d'assistance à la clientèle. Nos coordonnées sont les suivantes:

 416-792-6088

 customerservice@aosom.ca

Imported by Aosom Canada Inc.
7270 Woodbine Avenue, Unit 307, Markham,
Ontario Canada L3R 4B9
MADE IN CHINA

Importé par Aosom Canada Inc.
7270 Woodbine Avenue, unité 307,
Markham, Ontario Canada L3R 4B9
Fabriqué en Chine

UK

If you have any questions, please contact our customer care center.

Our contact details are below:

 0044-800-240-4004

 enquiries@mhstar.co.uk

IMPORTER ADDRESS:
MH STAR UK LTD
Unit 27, Perivale Park,
Horsenden lane South
Perivale, UB6 7RH
MADE IN CHINA

FR

Si vous avez la moindre question, veuillez contacter notre centre d'assistance à la clientèle.

Nos coordonnées sont les suivantes:

 0033-1-84166106

 aosom@mhfrance.fr

Importé par:
MH France
2, rue Maurice Hartmann
92130 Issy-les-Moulineaux
France
Fabriqué en Chine

ES

Si tiene alguna pregunta, comuníquese con nuestro Centro de Atención al Cliente. Nuestros datos de contacto son los siguientes:

 0034-931294512

 atencioncliente@aosom.es

IMPORTADOR:
SPANISH AOSOM, S.L.
C/ ROC GROS, N° 15. 08550, ELS HOSTALET DE
BALENYÀ, SPAIN.
B66295775
WWW.AOSOM.ES
ATENCIONCLIENTE@AOSOM.ES
TEL: 931294512
HECHO EN CHINA

PT

Se tiver alguma dúvida, por favor contacte o nosso Centro de Atendimento ao Cliente. Os nossos dados de contacto são os seguintes:

 0034-931294512

 info@aosom.pt.

IMPORTADOR:
SPANISH AOSOM, S.L.
C.ROC GROS N.15, 08550. ELS HOSTALET DE BALENYÀ
TEL: 931294512 (SEG-SEX DAS 7:30H ÀS 16:30H)
INFO@AOSOM.PT
WWW.AOSOM.PT

DE

Wenn Sie Fragen haben, wenden Sie sich bitte an unser Kundendienstzentrum. Unsere Kontaktdaten stehen unten:

 0049-0(40)-88307530

 service@aosom.de

ADRESSE DES IMPORTEUR:
MH Handel GmbH
Wendenstraße 309
D-20537 Hamburg
Germany
IN CHINA HERGESTELLT

IT

In caso di dubbio, si prega di contattare il nostro centro assistenza clienti. I nostri dettagli di contatto sono di seguito:

 0039-0249471447

 clienti@aosom.it

IMPORTATO DA:
AOSOM Italy srl
Centro Direzionale Milanofiori
Strada 1 Palazzo F1
20057 Assago (MI)
P.I.: 08567220960
FATTO IN CINA

Jouets, bricolage et jardinage

 **FR**
DONNEZ
OU
RECYCLEZ

 OU  OU 
ASSOCIATION LIVRAISON DÉCHÈTERIE

Adresses sur quefairedemesdechets.fr

Généralistes

 **FR**
Pensez à
donner ou recycler.

 OU  OU 
Association Magasin Déchèterie

<https://quefairedemesdechets.fr>